



CORNELL PUMP COMPANY INDUSTRIAL



EFFICIENT BY DESIGN



INDUSTRIAL



IMPELLERS

Cornell's two- and three-port enclosed, non-clog impellers are designed to handle large solids and maintain exceptional hydraulic efficiencies. Cornell's Delta™-style impeller is specifically designed for handling stringy materials and heavy sludge for low- to medium-head applications and our three- or four-vane, semi-open impeller generates a cutting action designed to handle concentrated slurries for high head applications.

SOLIDS HANDLING PUMPS ENCLOSED IMPELLER

Cornell Solids Handling Pumps are used for waste water, sludge, stringy material, dewatering, abrasive transfer, canneries, construction, dredging, lumber mills, slush ice, reclamation plants and foundry or mill slag.

Available with Delta™, Semi-open, Enclosed, and Chopper impellers, Cornell pumps are offered in various discharge sizes ranging from 3 to 30 inches, with heads to 470 feet TDH, and flow rates of up to 38,000 GPM.

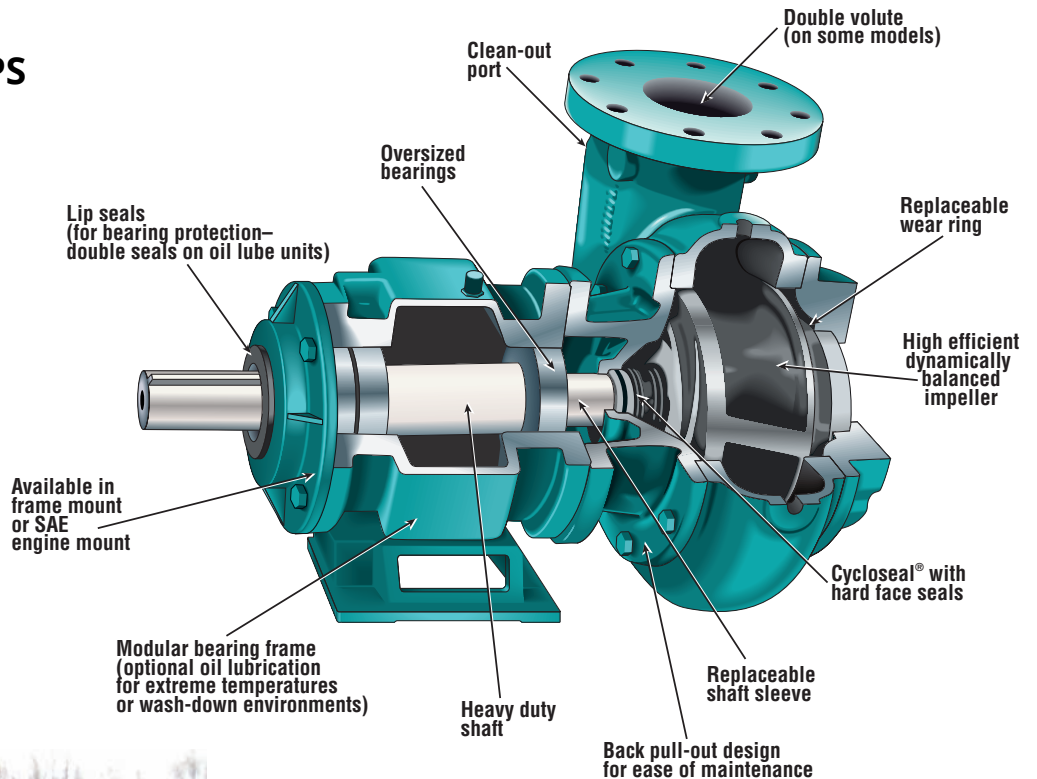

SOLIDS HANDLING PUMPS, ENCLOSED IMPELLER

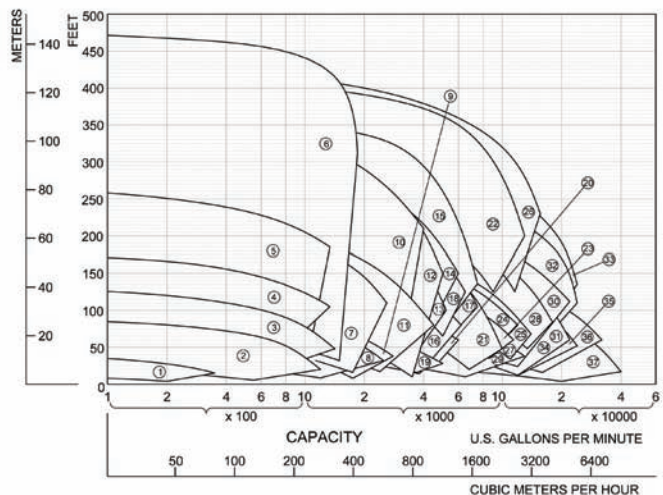

- | | | | | |
|----------|------------|-------------|-------------|-------------|
| 1. 3NLT | 9. 6NHT/TH | 17. 10NHTBH | 25. 14NHGH | 33. 18NHG34 |
| 2. 4NNTL | 10. 6NHTB | 18. 10NHTA | 26. 14NHG28 | 34. 20NHFL |
| 3. 4NNT | 11. 8NNT | 19. 12NHTL | 27. 16NHGH | 35. 20NHF |
| 4. 4NHTA | 12. 8NHTA | 20. 12NHTM | 28. 16NHG22 | 36. 24NNG |
| 5. 4414T | 13. 8NHTH | 21. 12NNTF | 29. 16NHG32 | 37. 30NNT |
| 6. 4NHTB | 14. 8NHTR | 22. 12NHG28 | 30. 18NHG | |
| 7. 6NHTA | 15. 8NHGA | 23. 14NHG | 31. 18NHFL | |
| 8. 6NNT | 16. 10NHTB | 24. 14NHGA | 32. 18NHG34 | |

CHOPPER PUMPS

With its heavy duty, ASTM A536 grade 65-45-12 ductile iron construction, using our patented Cycloseal® design (patent #5489187), the Cornell Chopper pump is ideally suited for chopping solids. The replaceable cutter bar is made of T1 tool steel, heat treated to a minimum 60 Rockwell C hardness. Heat treated impellers of cast alloy steel, AISI 8630, and 416 stainless steel shaft sleeves are standard. The bearing frame is fitted with heavy-duty back-to-back angular contact ball bearings to handle axial loads and provide exceptional bearing life. Our Chopper pumps are fitted with a John Crane type 2 tungsten carbide mechanical seal as standard with an optional Run-Dry™ seal system available. TDH ranges from 30-200 feet with flows ranging from 0-1500 GPM.



SUBMERSIBLES

Cornell uses the same high efficiency pump-ends for our submersibles that have been proven time and again in standard municipal applications. Coupled with the highest quality motors, Cornell's submersible product line provides the best possible value.

DELTA™ STYLE PUMPS

Cornell's Delta™ impeller vanes extend continuously across the pump's suction entrance and their trailing edges reduce low pressure areas. Two distinct vortices are created which pass solids through the impeller. The absence of sharp impeller edges prevents "hair pinning" or hang-up of stringy materials. Larger solids are effectively broken up by the comminuting action of the impeller vanes. Many of our enclosed impeller type pumps can be retrofitted with Delta™ style impellers.



DELTA™

Pump Sizes: 3" x 3", 4" x 4", 6" x 6", 8" x 8", and 10" x 10"

Capacities: 50 GPM to 5,000 GPM

Heads: 10 Feet to 450 Feet

CHOPPER PUMP CURVES

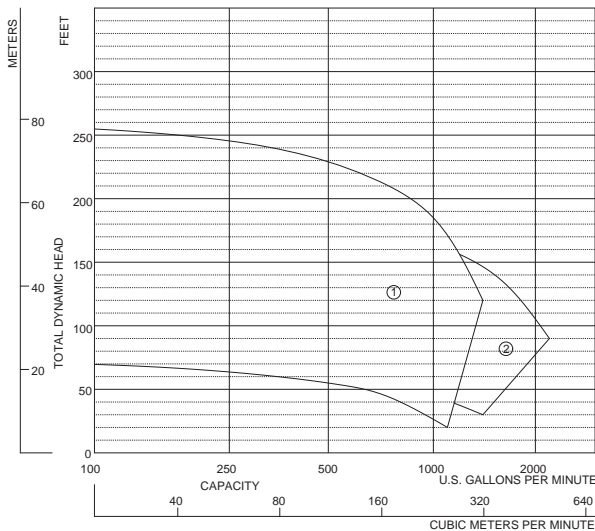

1. 4NC
2. 6NC

SOLIDS HANDLING PUMPS, DELTA™ IMPELLER

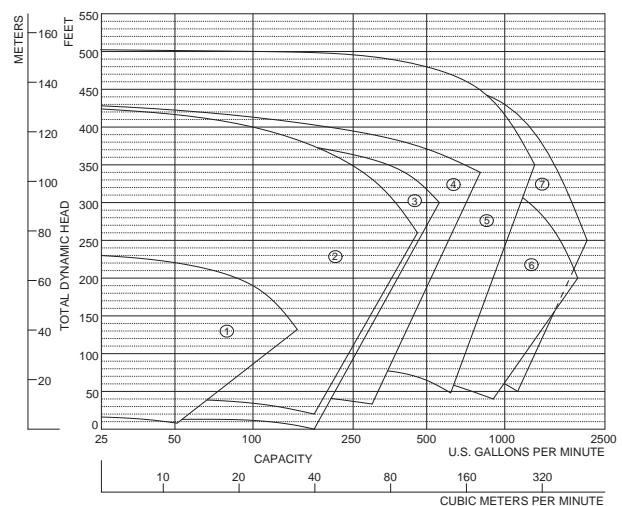

1. 3NLA
2. 4NLDL
3. 4NNDH
4. 4NHDL
5. 4NHM
6. 6NHDL
7. 6NHM
8. 6NNDH
9. 8NNDH
10. 10NNDH

INDUSTRIAL PROCESS



Cornell offers a comprehensive line of standard and special purpose industrial process centrifugal pumps including 1" to 30" discharge diameters. We offer premium quality centrifugal pumps that incorporate highly engineered features specifically designed to enhance performance and longevity.

CLEAR LIQUID PUMPS

Cornell Clear Liquid Pumps are used for commercial and residential irrigation, golf course and lawn maintenance, aqua culture, fountains, breweries, laundries cooling towers, fire fighting, reverse osmosis feed, and water boosters. The W, Y, R and H series pumps are available in a wide range of materials with discharge sizes ranging from 1 to 10 inches, heads to 450 feet TDH, and flow rates up to 7,000 GPM.

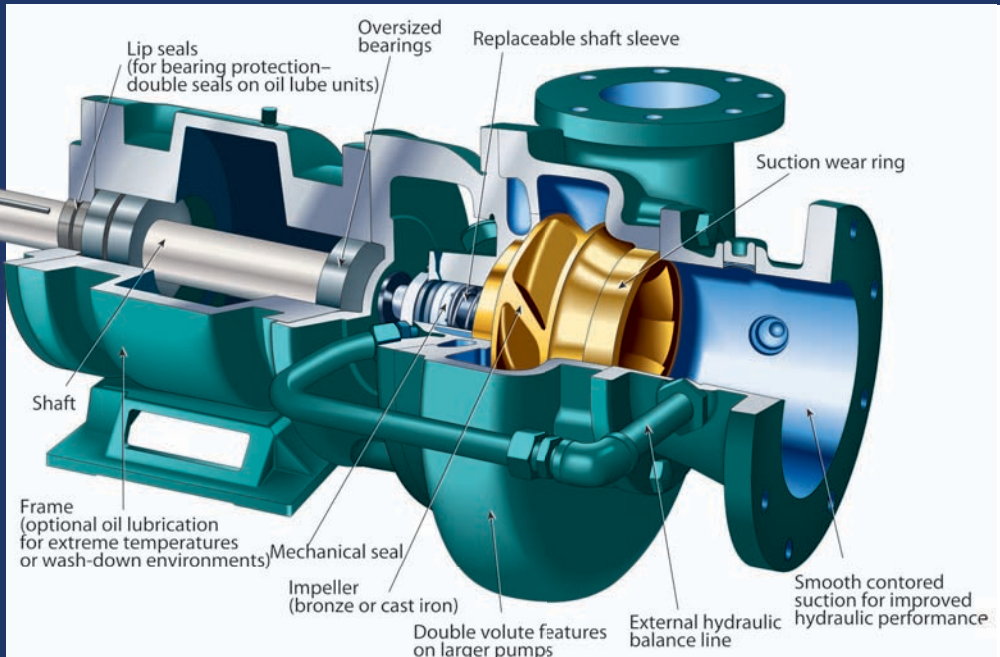

QUALITY MATERIALS

Cornell's industrial process and wastewater pumps are constructed entirely of iron. Standard features include: dual-plane and dynamically balanced impellers, heavy-duty shafts with replaceable shaft sleeves, and replaceable wear ring(s). Other materials of construction are available as an option for abrasive or caustic applications.

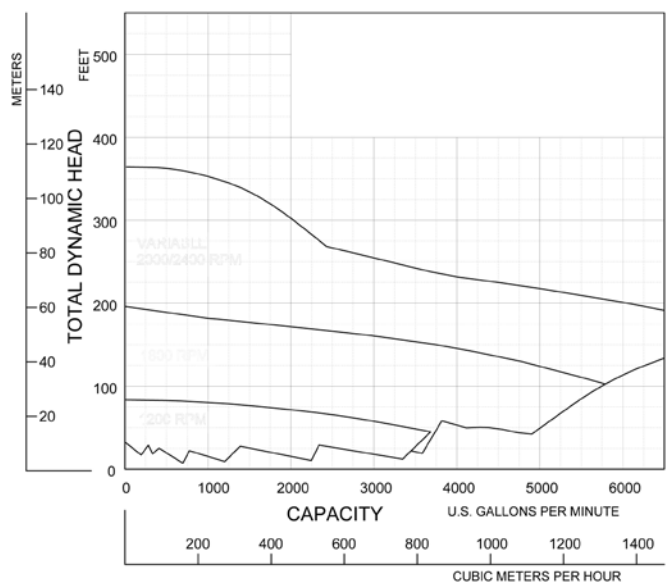
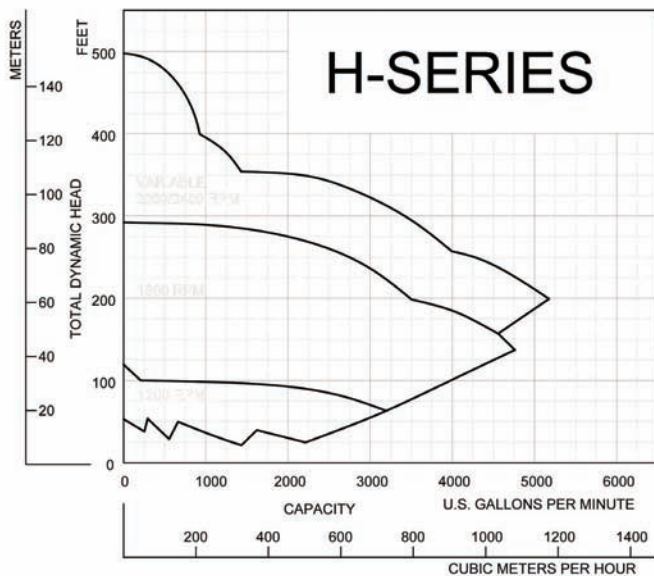

INDUSTRIAL PROCESS

ENERGY EFFICIENCY

Cornell pumps are designed to deliver best in class efficiency. Depending on operating hours, fuelant, and horsepower required, you can save \$3,000 per year (or more) in energy costs. Cornell manufactures more than 60 clear liquid and non-clog pumps that meet or exceed optimum efficiency standards for centrifugal pumps.

Select High Efficiency Pump Models:

- 8H — 88% efficient
- 6R — 89% efficient
- 5RB — 86% efficient
- 4RB — 85% efficient

EXTERNAL HYDRAULIC BALANCE LINE

Cornell's external hydraulic balance line equalizes pressure between the impeller hub area and the pump suction to reduce axial loading acting on the impeller, shaft and bearings. The balance line also assists in moving sand and silt from the stuffing box to the low pressure area at the pump suction, reducing wear of the wetted parts.

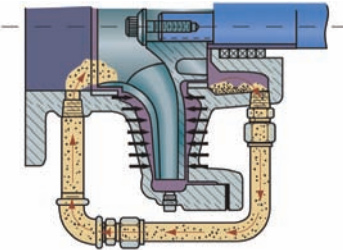

DOUBLE VOLUTE

Cornell introduced the double volute as an industry first more than 30 years ago. The double volute system effectively balances forces within the pump to reduce radial load, shaft deflection and fatigue. This eliminates shaft breakage and extends the service life of packing and mechanical seals, wear rings and bearings while maintaining high hydraulic efficiency.

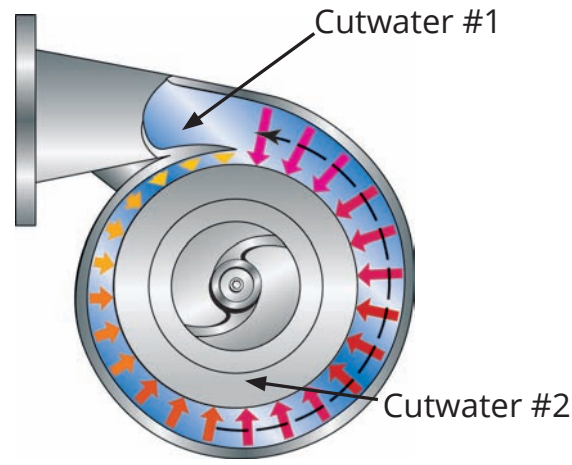

DOUBLE VOLUTE

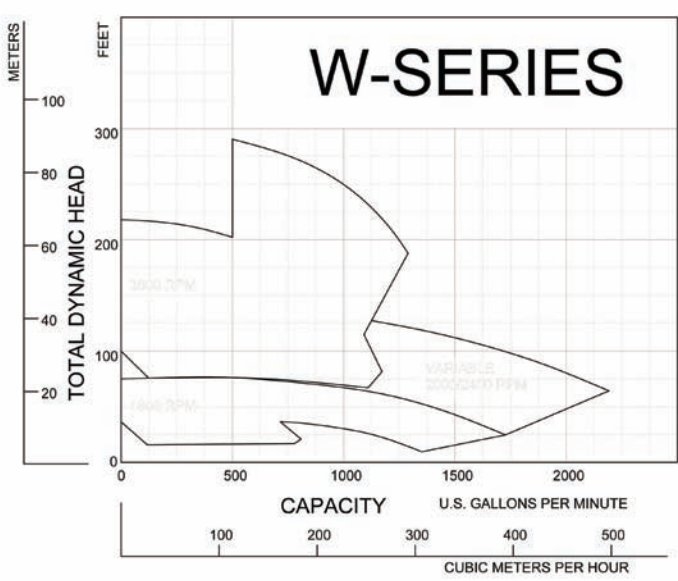
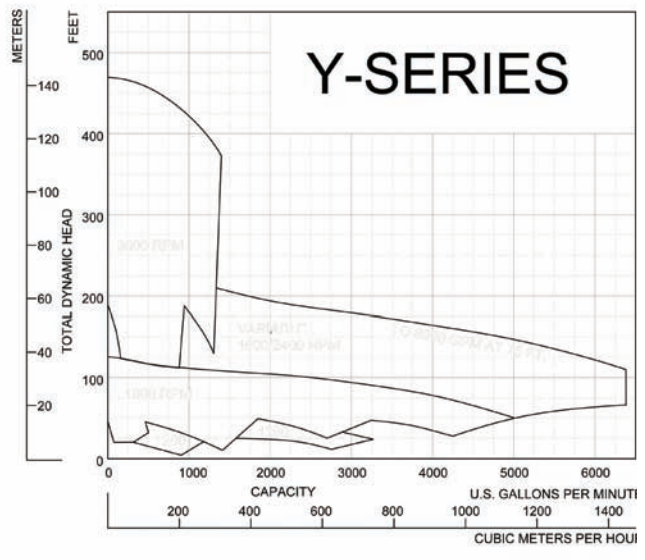

CONSTRUCTION

Cornell's dry priming (as opposed to wet priming) is the best solution available to address the self-priming needs of the construction and de-watering industries. Cornell has built its worldwide reputation on quality and reliability. Our Redi-Prime® pumps are engineered and manufactured to provide ultra-reliable, trouble-free operation. Hydraulic efficiencies typically exceed 80% – significantly higher than what is provided by our competition. Moreover, Cornell's automatic priming and re-priming is achieved with a 50 SCFM diaphragm vacuum pump.

DEWATERING

Cornell's priming system was specifically designed with the environment in mind. By using a positive sealing float box and a diaphragm vacuum pump, there is absolutely no water carry-over to contaminate the environment. Cornell Redi-Prime® pumps are designed with the suction larger than the discharge. This provides more flow due to reduced friction losses. Suction lifts of 28 feet and heads of up to 470 feet are possible depending on suction losses and operating points on the pump curve.



SETTING THE STANDARD

Cornell's Redi-Prime® pumps are designed and engineered for the most rugged and demanding industries – construction, industrial, rental, and municipal. With over 50 years of proven experience and reliability, Cornell Pump Company has established the highest industry standard for premium quality and performance in the most rugged conditions. Cornell pumps are backed by an industry-leading two-year warranty.

Redi-Prime® Benefits:

- Fully automatic self-priming, dry-prime pump
- Handles air/liquid mixtures with ease
- Rapidly primes and re-priming completely unattended
- Environmentally safe priming system designed to prevent product leakage
- Patented Cycloseal® and Run-Dry™ options
- Handles large size solids
- High suction lift capability up to 28 feet
- Premium hydraulic efficiency for reduced energy consumption
- Total dynamic head up to 470 feet

REDI-PRIME® COMPONENTS

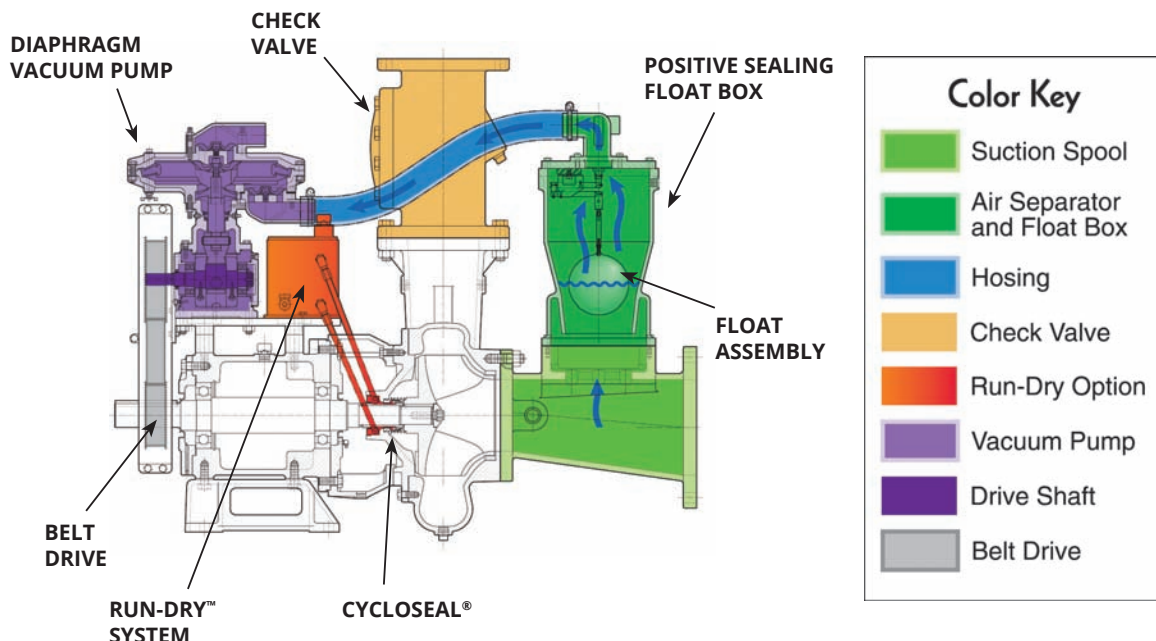

PUMP OPTIONS: SOLIDS HANDLING PUMPS						
MODEL	DISCHARGE SIZE	MAX CAPACITY (GPM)	MAX SOLIDS	MAX HEAD	MAX SUCTION LIFT	RPM
4NNTL	4"	1450	3"	175'	25'	2500
4NNT	4"	1400	3"	150'	25'	2000
4NHTA	4	1400	3	225	25	2100
4414T	4	1400	3	350	25	2000
4NHTB	4	1600	3	425	25	2000
6NHTA	6	2700	3	280	25	2000
6NNT	6	2550	3	150	25	2100
6NHTB	6	4250	3.38	350	25	1800
8NNT	8	4500	3.38	255	25	1900
8NHTA	8	5000	3.38	350	25	1800
8NHHTH	8	6250	4	255	25	1200
10NNT	10	6300	4	340	25	1800
10NHTB	10	8000	4.75	195	25	1200
10NHTA	10	6400	4.25	245	25	1200
12NHTL	12	5200	4.25	140	25	1500
12NNF	12	8500	3	195	25	1800
12NHG28	12	12000	3.2	410	25	1200
14NHG	14	12000	4	210	25	1500
14NHGH	14	13500	4.25	145	25	1200
14NHG28	14	15000	4.25	430	25	1200
16NHGH	16	13500	4.25	175	25	1200
16NHG22	16	16500	4.5	265	25	1200
18NHG	18	22000	5	220	25	900
18NHFL	18	26000	5	190	25	890
18NHFL34	18	22000	4.5	320	25	900
20NHFL	20	18000	5	116	25	720
24NNG	24	32000	5.25	135	25	750
30NNT	30	38000	10.2	110	25	585

PUMP OPTIONS: SOLIDS HANDLING PUMPS						
MODEL	DISCHARGE SIZE	MAX CAPACITY (GPM)	MAX SOLIDS	MAX HEAD	MAX SUCTION LIFT	RPM
2.5RB	2.5	400	.38	300	25'	2200
2.5H	2.5	500	.41	360	25'	2200
2.5YH	2.5	750	.41	310	28	3000
3HC/HA	3	1050	.5	490	28	2400
3RB	3	800	.5	280	28	2200
3YL/YH	3	1100	.5	245	28	2700
4HC	4	1650	.62	470	28	2150
4RB	4	1550	.84	270	25	2200
5HH	5	2900	.75	375	25	2000
5RB	5	2350	1	360	25	2400
5YBH	5	2500	.75	200	25	2400
6HH	6	4000	1.22	365	25	2000
6RB	6	4250	1.31	300	28	2200
6YB	6	4100	.75	235	25	2400
8H	8	5400	1.25	305	25	2000
10RB	10	7000	1.25	300	25	2200
10YB	10	6500	1.38	200	25	2300

REFRIGERATION & COOLING

QUALITY ASSURANCE

Cornell Pump Company proudly maintains its ISO 9001:2008 certification which validates that Cornell is in compliance with all necessary processes to meet customer requirements.

The elements associated with ISO 9001:2008 certification include such areas as contract review, design and development, production, purchasing, quality control and service.

Cornell liquid over-feed and transfer pumps are designed and manufactured specifically for industrial refrigeration applications such as cold storage, food processing, ice chiller, and turbine inlet cooling. With decades of proven experience and reliability, Cornell has established the highest industry standard for premium quality performance in meeting the demands of the industrial refrigeration marketplace. Our products are engineered to be rugged and dependable; each Cornell refrigeration pump is backed by an industry-leading three-year warranty.

INDUSTRIAL REFRIGERATION

Enhanced vapor handling and NPSHR characteristics are at the heart of Cornell's liquid overfeed pump innovations and we have incorporated these design features into our liquid overfeed and transfer pump designs. Cornell refrigerant pumps are commonly employed in applications utilizing anhydrous ammonia, aqueous ammonia, halocarbon such as R-22, and other approved refrigerants. The pumps are designed specifically to handle moderate to high pressure differentials.

Cornell's refrigeration product line offers the customer a choice between the standard "Refrigerant Emission Free" sealing technology or our Seal-less hermetic technology. Both offer dynamic containment systems capable of continuous and reliable operation.

SATURATED LIQUIDS

Cornell Pump Company's CBH/CB pump series are a welcome alternative to regenerative turbines, especially for requirements associated with boiler feed, condensate return and other saturated liquid applications. Cornell's single stage centrifugal CBH/CB pumps are capable of achieving capacities up to 400 GPM and pressure differentials of 140 PSI while maintaining NPSH requirements of less than two feet.

The extremely low NPSH requirements of all Cornell CBH/CB pumps are derived from hydraulics designed specifically for saturated liquid applications. Performance is further enhanced throughout the entire operating range of all Cornell CBH/CB series pumps due to the single-stage impeller and 1800 RPM operating speed. Operating speeds above 1800 RPM are available for applications associated with higher head requirements.

GLYCOL

In many refrigeration applications, secondary coolants such as ethylene and propylene glycols are used as heat transfer media. The secondary brine is cooled by the primary refrigerant and used to transmit heat without changing state. Cornell's clear-liquids-handling pumps are commonly used to recirculate the secondary coolants. These pumps are rugged, extremely efficient and designed specifically for a long life of service.

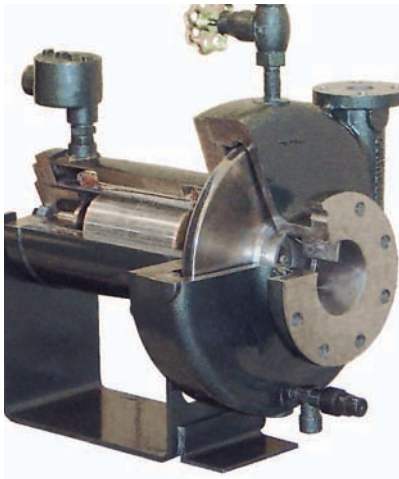

FOOD PROCESS

HYDRO-TRANSPORT FOOD HANDLING

Cornell engineers understand the important role food handling pumps play in today's marketplace. Cornell's innovative single port impeller configuration with an offset volute provides the end user with a food handling pump capable of transporting even the most delicate / difficult food products such as cherries, lettuce, potatoes, or carrots. Cornell's unique single port impeller reduces product damage and ensures product integrity. The single port impeller is a proven feature consisting of a large and rounded leading vane edge designed specifically for handling whole or processed foods.



HOT COOKING OIL

Enhanced vapor handling and NPSHR characteristics are central to Cornell's latest hot cooking oil pump innovations. When fresh product passes through the fryers a great deal of water is evolved. The water travels along the bottom of the fryer, intact, in a liquid phase at 392° F (200° C), until it reaches the pump suction where the action of the impeller breaks the water up into smaller droplets that flash into steam. Ordinarily, entrained steam would severely impair the pump's head and flow, but another Cornell innovation prevents this type of reduced efficiency. The 'vapor suppression line' was developed in response to this phenomenon.



FOOD PROCESS & WASTE

Cornell's food product group is not limited to food handling and hot cooking oil applications. Cornell's process and waste pumps are frequently used in starch recovery, water return, circulation, chilled water, food product waste and many other food process applications. Cornell's clear liquid pumps are constructed entirely of iron for food applications. Many optional metalurgies are also available. Standard features include fully machined impellers, heavy-duty shafts with replaceable shaft sleeves, and peripheral wear rings.



MANUFACTURING

Cornell pumps are of superior quality, with each part machined and built to our exacting standards.

Our team of exceptional machinists, craftsmen and assembly mechanics work with some of the most modern manufacturing machinery and hydraulic testing equipment in the world to bring our customers a state-of-the-art product.



ENERGY RECOVERY

COMMITMENT TO EXCELLENCE

As Cornell employees, we share the commitment to meet the requirements of our customers. We will provide services, parts, and products that satisfy all the agreed upon requirements.

We shall strive for a working environment of continual improvement by keeping the following priorities in mind:

1. Achieve total satisfaction on the basis of team effort.
2. Do the job right the first time to achieve consistent, on-time performance.
3. Put quality first. If all requirements have not been met, we will never knowingly complete a service, transaction, or ship a part or product for the sake of 'being on time'.

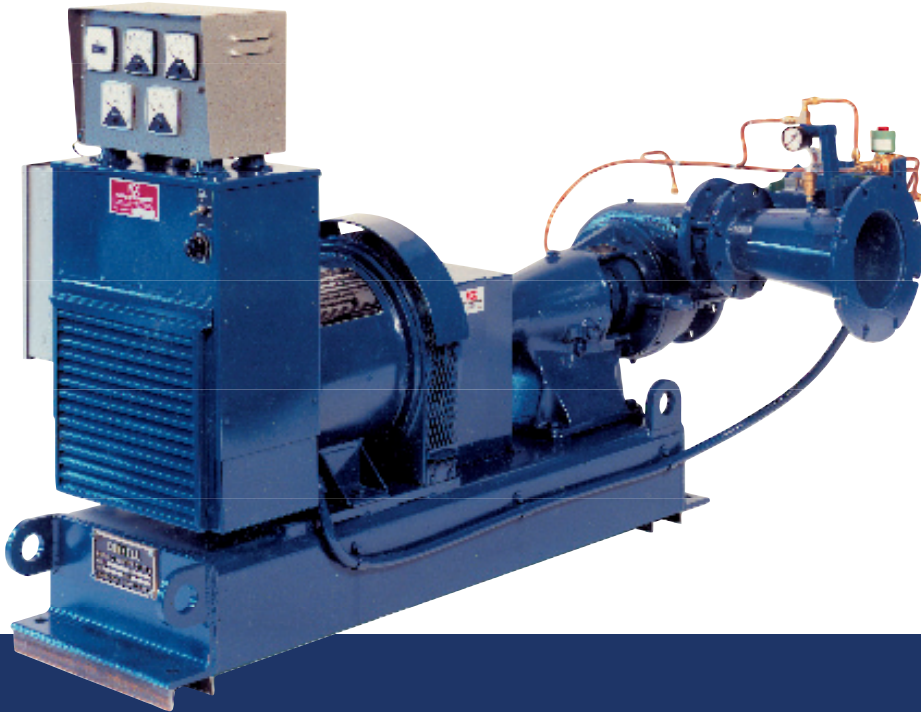
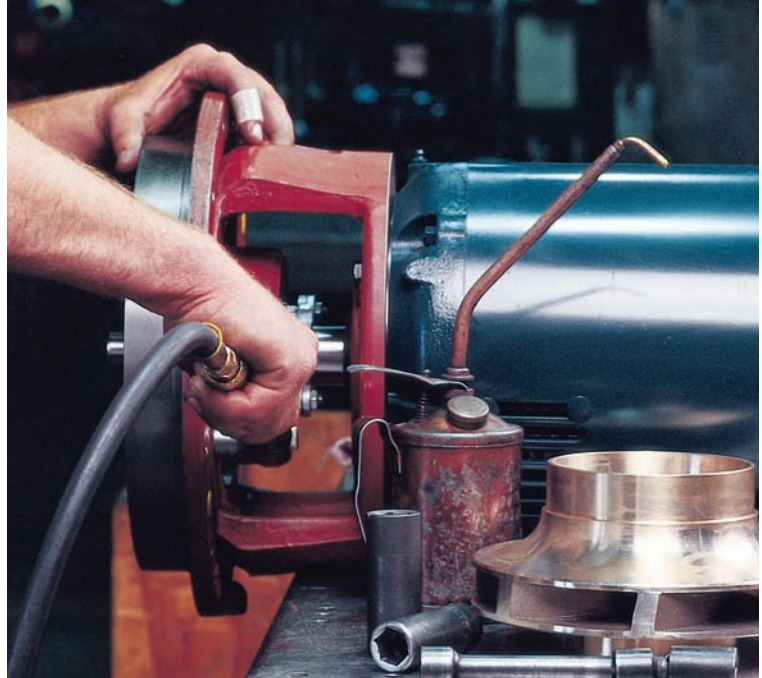

TURBINE APPLICATIONS

Many industrial operations are able to harness the potential hydraulic energy sources required to produce electric power as a revenue source or as a means of reducing overall energy demands.

The key to our system is the recovery of excess head from a river, stream, or pipeline to drive a Cornell turbine. The turbine may be used to drive a pump, a generator or other power requiring device.

With power production available from 1 kW to 300 kW, Cornell's range of high-efficiency turbines can generate enough power to pay for themselves in a very short time.

Whether you require a single or parallel unit, Cornell engineers and sales personnel can provide specialty application assistance.

MOUNTING CONFIGURATIONS

Cornell's Modular Frame design allows for easy adaptability. Choose a pump, then pick the mounting configuration best suited to your application. Right hand and left hand rotation along with tangential or centerline discharges are available for most pumps.

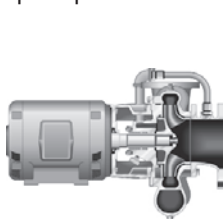

CC
Horizontal
Close Coupled

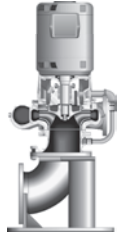

VM
Vertical
Close
Coupled

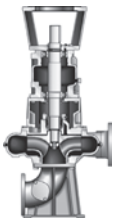

VC
Vertical
Coupled

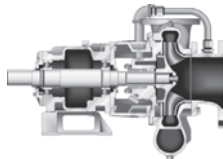

F
Horizontal
Frame
Mounted

CYCLOSEAL®

The Cycloseal® is a self-contained single mechanical seal upgrade for the standardized food grade packing feature. It requires no external flushing which is ideal for eliminating the water usage normally associated with mechanical seals. The Cycloseal® uses stationary 'vanes' cast into the pump backplate to create pressure gradients that move solids away from the seal faces. As a result, the requirement for an external water flush line for abrasive service is avoided. The Cycloseal® design is available in all food handling pumps.

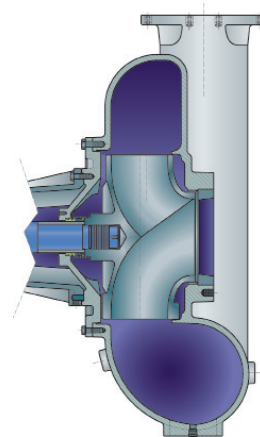

FOOD

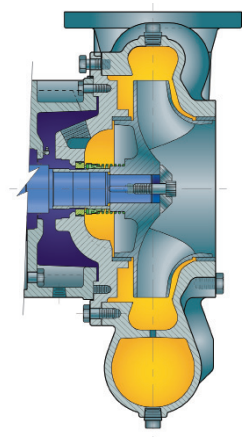

Hot Oil

RUN-DRY™ OPTION

Run your pump dry without the use of expensive water systems and without mechanical seal damage. Cornell's Run-Dry™ system consists of an auxiliary gland which provides containment for an application-specific lubricant present at the inside diameter of the mechanical seal faces. This lubricant prevents dry running of the seal faces while priming, re-priming, and on standby. The Run-Dry™ gland is connected to a lubricant reservoir via inlet and outlet lines which are oriented tangentially to the pump shaft so that shaft rotation provides circulation and subsequent cooling of the lubricant.

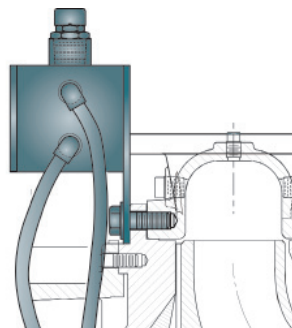
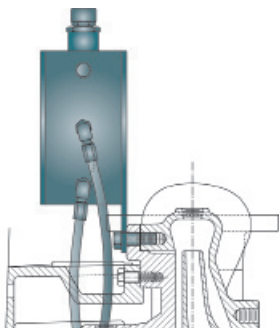

DOUBLE VOLUTE DESIGN

The double volute system enables Cornell single-stage, end-suction centrifugal pumps to easily perform big volume and high pressure jobs. On single volute pumps, the increasing pressure acts against the impeller area and creates unbalanced radial forces. By contrast, the Double Volute System effectively balances these forces around the impeller to reduce shaft flexure and fatigue for longer seal life, bearing life and shaft life.

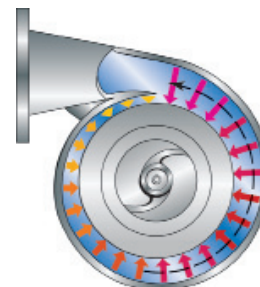

Single
Volute

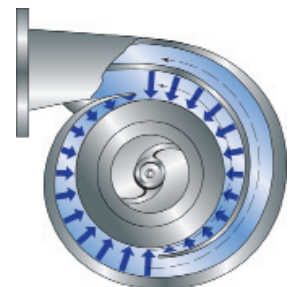

Double
Volute



MARKET AND PRODUCT LINE



AGRICULTURAL



FOOD PROCESS



INDUSTRIAL



MINE DEWATERING



MUNICIPAL

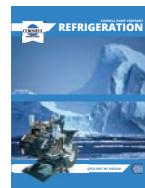

REFRIGERATION

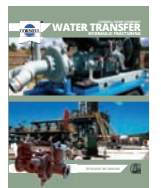

WATER TRANSFER



CHOPPER



CUTTER



EDGE™



HYDRAULIC SUBS



HYDRO TURBINE



IMMERSIBLE



MANURE



MP SERIES



MX SERIES



OIL & GAS



REDI-PRIME®



STX SERIES



SLURRY



SUBMERSIBLE

Cycloseal®, and Redi-Prime® are Registered Trademarks of Cornell Pump Company.

Cornell pumps and products are the subject of one or more of the following U.S. and Foreign patents: 3,207,485; 3,282,226; 3,295,456; 3,301,191; 3,630,637; 3,663,117; 3,743,437; 4,335,886; 4,523,900; 5,489,187; 5,591,001; 6,074,554; 6,036,434; 6,079,958; 6,309,169; 2,320,742; 96/8140; 319,837; 918,534; 1,224,969; 2,232,735; 701,979 and are the subject of pending U.S. and Foreign Patent Applications.



Cornell Pump Company
 16261 SE 130th Ave
 Clackamas, OR 97015
 P: (503) 653-0330
 F: (503) 653-0338



CORNELLPUMP.COM
 ©2013 CORNELL PUMP COMPANY